

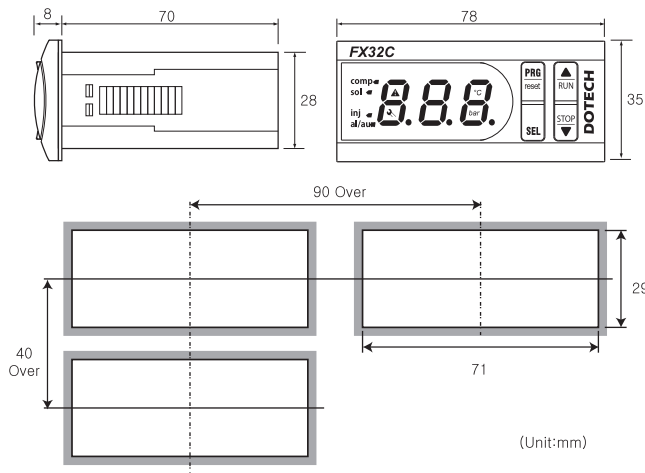

■ Dimensions and Panel Cut-Out Form



⚠ PreCaution for Use

1. This product may cause an electric shock in handling. Please do not attempt to open it with power turned on.
 2. This product should be installed in a place fixed secured by a rack or panel.
 3. This product can be used under the following environmental condition
 - ① Indoor ② Pollution Degree 2 ③ At an altitude of 2000m or below ④ Installation Category II
 4. To turn on or turn off power supply for this product, please the circuit breaker or switch of a standard product of IEC 60947-1 or IEC 60947-3 product and install it within a close distance allowing convenient operation by user.
 5. Please be understood that if this product is dismantled or modified discretionary, after sales service will not be able to be provided.
 6. An output wire to be used for this product should be inflammable grade FV-1 (V-1 grade or above), the thickness of the wire should be AWG No. 20 or above. (0.50mm²)
 7. In order to prevent at inductive noise, please maintain the high-voltage wire and power wire separated.
 8. Avoid installing the product in a place where a strong magnetism, noise, severe vibration and impact exist.
 9. When extending the sensor wire, use a shield wire and do not extend it unnecessary long.
 10. The sensor wire and signal wire should be away from the power and load wires using conduits separately installed.
 11. Avoid using the product near a device generating strong high frequency noise (high-frequency welding machine, high-frequency sewing machine, high-frequency radiotelegraph, high capacity SCR controller)
 12. PRODUCT'S DAMAGES OTHER THAN THOSE DESCRIBED IN THE GUARANTEE CONDITIONS PROVIDED BY THE MANUFACTURER SHALL NOT BE RESPONSIBLE BY US.
- ※ The Aforementioned precautions must be observed, and if you fail to do so, it may cause a product's breakdown.

■ Constitution (Function of Display Ramp and Button)

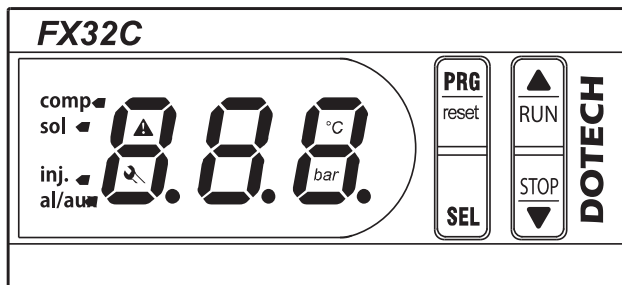

■ Basic Specification

Model	FX32C Comptector
Power	AC100 - 240V~, 50/60Hz, 8VA
Connector	Connector (Molex)
Input / Output	Relay output 4p (250Vac/10A) Temp. sensor input 3p Digital input 7p
Operation	Temp. : -10~50°C, Humidity : Under 90%RH
Storage	Temp. : -20~60°C, Humidity : Under 90%RH
Sensor	Ctrl. Temp. sensor : DOTECH Standard NTC sensor DPR-TH01-ET 5kΩ at 25°C, Limit : -50 ~ 105°C, Accuracy : ±0.3°C at 25°C Discharge gas Temp. sensor : DOTECH Standard NTC sensor DPR-TH02 10kΩ at 25°C, Limit : -40 ~ 150°C, Accuracy : ±1.5°C at 25°C

■ Order Information

FX32C - 00 : Basic Model
FX32C - 30 : Discharge gas watch & Liquid Injection Applicable Model
FX32C - 40 : FX32C-30 & Control of temp. Applicable (for Chiller, CDU)
- 00 : Not include Communication Model
- R4 : RS485 Communication(Modbus RTU/ASCII)
Private Cable : FXC-12P-20, FXC-14P-20 (2.0m) (* Not include)
Ctrl. Temp. Sensor : DPR-TH01-ET (* Not include)
Discharge gas Temp. Sensor : DPR-TH02-P6D50L * 3m (* Not include)

■ Connection Diagram

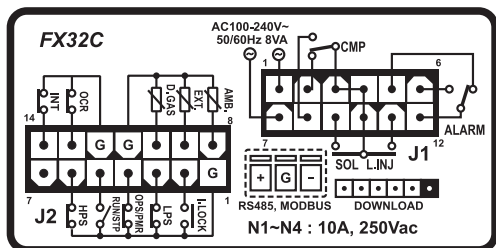

- | | |
|----------------------------|------------------------|
| N1 : COMP RUN/STOP | ID1 : OCR |
| N2 : SOL ON/OFF | ID2 : INT |
| N3 : Liquid Injection SOL | ID3 : HPS |
| N4 : ALARM | ID4 : OPS / PMR |
| B1 : AMB.(OUT) TEMP SENSOR | ID5 : LPS |
| B2 : EXT.(IN) TEMP SENSOR | ID6 : INTERLOCK |
| B3 : DISCHARGE GAS TEMP | ID7 : Remote(Run/Stop) |

comp	ON at comp. operation (Fast flickering at Running delay State, Slow flickering at Pump Down State)
sol	ON at Sol valve on. (Slow flickering at Re-running delay state)
inj.	ON at Liquid Injection Sol on.
al/aux	ON at alarm/aux. control output on
°C	ON at temp. display
!	ON at trip

PRG reset	-Program setup (Push for 3 sec.) -Alarm reset (Push 2 times quickly & successively)	RUN	-Moving between menus -Increasing/decreasing setup value -Push 1sec, Start running
SEL	-Execution for selected menu -Input of setup value	STOP	-Moving between menus -Increasing/decreasing setup value -Push 1sec, Stop running
PRG reset SEL	Confirm setup temp. and time	If pushing for 1 sec., it shows setup temp. for 2 sec. after that, Return to Display Present temp.	
RUN STOP	Confirm temp. sensor	If pushing for 1 sec. it displays B1 temp. ▶ B2 temp. ▶ B3 temp. ▶ Current state (B1: Comp. LED flickering, B2: Sol LED flickering, B3: Inj LED flickering)	
PRG reset RUN	Initializing setup value	If pushing for 2 sec. with power input, setup value is initialized	

Connection Diagram

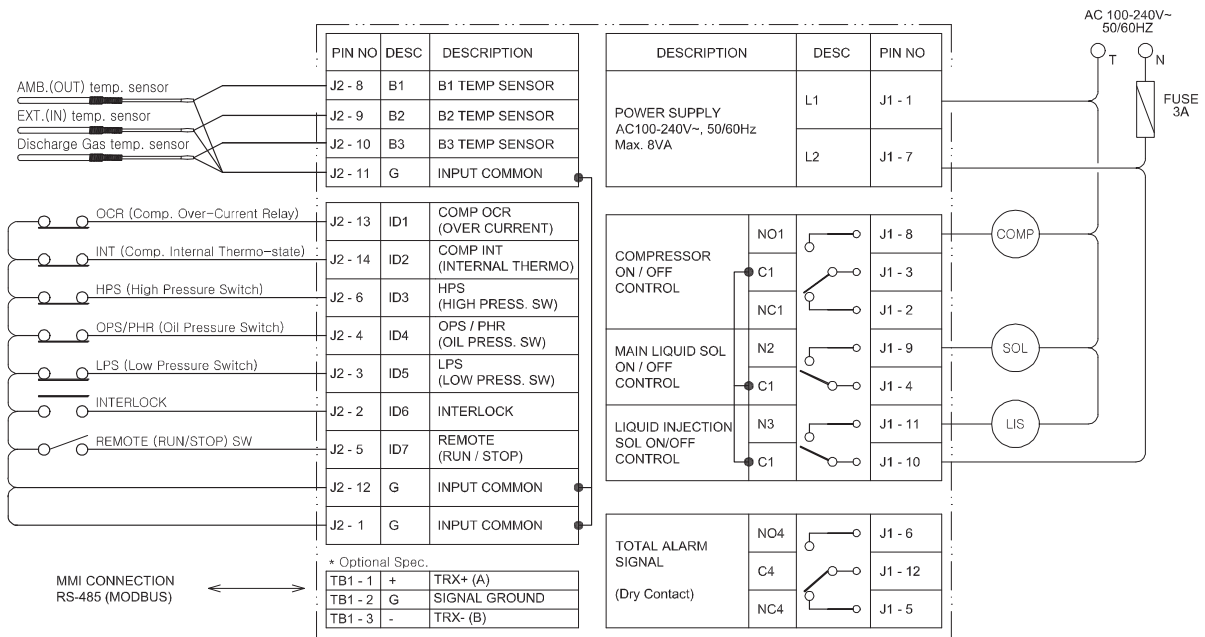

Quick Setup (Required temp., Control deviation, Defrost termination temp., Defrost cycle)

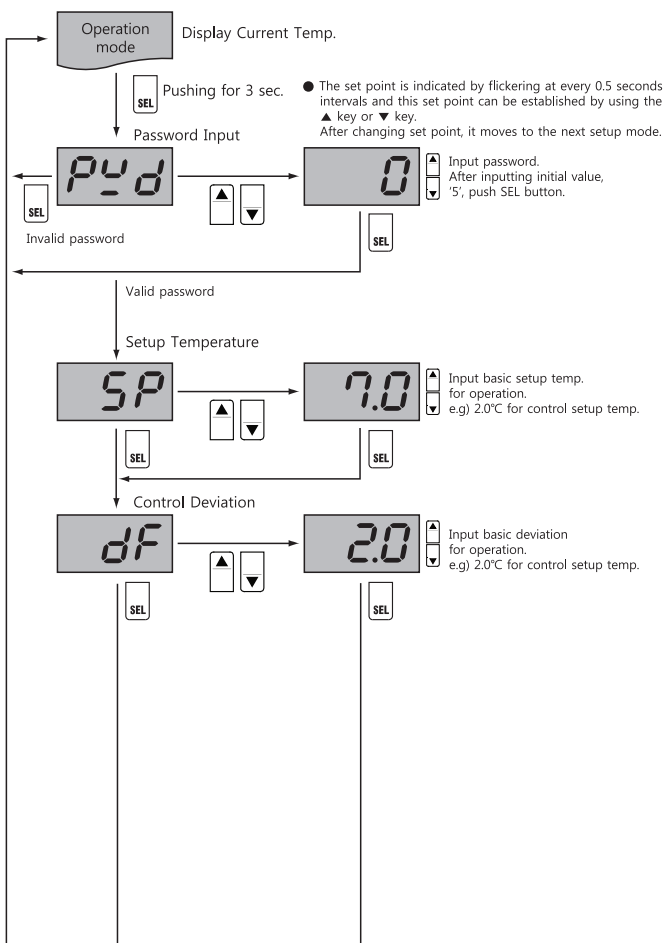

Changing and Confirming All Data At Once

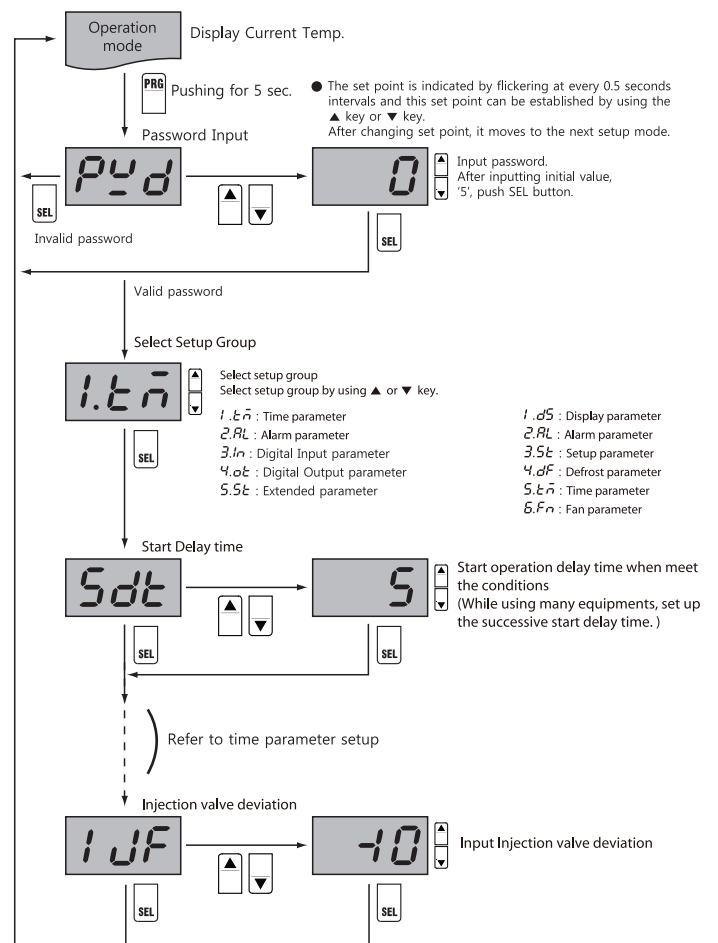

- If there's no input made for a period of 180 seconds during the setting, then it returns back to the run mode automatically
- 비밀번호를 입력한 후 3분동안은 다시 입력하지 않아도 됩니다.

- If there's no input made for a period of 180 seconds during the setting, then it returns back to the run mode automatically

TRIP / ALARM MESSAGE

ITEM	DESCRIPTION	CODE	REMARK	OPERATION WHEN SENSING	RESET
1	Internal Control factor error (※ 1)	<i>5YS</i>	Sensing Condition : Internal control factor changed by unkwon noise Cancel Condition : Factor Setting again	Stop at once	Manual
2	Outlet Temp. Sensor error	<i>1Er</i>	Sensing Condition : Output temp. sensor is error(open/short) Cancel Condition : Output temp. sensor is normal	If Outlet Temp. Sensor CNTL. rate high Stop at once	Sensing Alarm After 1min. Manual, Before 1min. Automatic
3	Inlet Temp. Sensor error	<i>2Er</i>	Sensing Condition : Input temp. sensor is error(open/short) Cancel Condition : Input temp. sensor is normal	If Inlet Temp. Sensor CNTL. rate high Stop at once	Sensing Alarm After 1min. Manual, Before 1min. Automatic
4	Discharge gas Temp. Sensor error	<i>3Er</i>	Sensing Condition : Discharge gas temp. sensor is error(open/short) Cancel Condition : Discharge gas temp. sensor is normal	Stop at once	Sensing Alarm After 1min. Manual, Before 1min. Automatic
5	High Temp. Alarm	<i>HL</i>	Sensing Condition : PV is more than High Temp. sensing for High Temp. alarm delay time Cancel Condition : PV is down than High Temp. 0.5°C and less	Message	Automatic
6	Low Temp. Alarm	<i>LL</i>	Sensing Condition : PV is less than Low Temp. sensing for Low Temp. alarm delay time Cancel Condition : PV is Up than Low Temp. 0.5°C and more	Message	Automatic
8	Discharge gas over temp (※ 2)	<i>dto</i>	Sensing Condition : Discharge gas over temp is more over than {alarm}Discharge gas over temp trip) Cancel Condition : Discharge gas normal temp is lower than {alarm}Discharge gas over temp trip) -10°C	Stop at once	Manual
15	Discharge gas lower temp	<i>dtu</i>	Sensing Condition : Discharge gas temp. is less than {Alarm}Discharge gas low temp trip) (But, Sensing {Alarm}Discharge gas low temp sensing delay time) After Comp operation)	Stop at once	Manual
9	Compressor over current	<i>OC</i>	Sensing Condition : Comp. over current alarm input (ID1) open Cancel Condition : Comp. over current alarm input (ID1) close	Stop at once	Manual
10	Compressor Internal thermo	<i>It</i>	Sensing Condition : Comp. Internal thermo alarm input (ID2) open Cancel Condition : Comp. Internal thermo alarm input (ID2) close	Stop at once	Manual
11	High pressure	<i>HP</i>	Sensing Condition : High pressure alarm input (ID3) open Cancel Condition : High pressure alarm input (ID3) close	Stop at once	Manual
12	Oil pressure	<i>OP</i>	Sensing Condition : Oil pressure alarm input (ID4) open Cancel Condition : Oil pressure alarm input (ID4) close	Stop at once	Manual
13	Phase fail	<i>PH</i>	Sensing Condition : Phase fail alarm input (ID4) open Cancel Condition : Phase fail alarm input (ID4) close	Stop at once	Manual
14	Low pressure alarm	<i>LP</i>	Sensing Condition : Low Pressure is hunting more than appointment sensitive. (But, SOL Valve Open & sensing After{Alarm}Low temp alarm sensing delay time))	Stop at once	Manual
16	Interlock alarm	<i>IL</i>	Sensing Condition : Interlock alarm input(ID6) open Sensing After Start {alarm}Interlock alarm sensing delay time) Sensing After Interlock signal {alarm}Interlock alarm start delay time) (But, If {Alarm}Interlock alarm sensing delay time)is '0', Always Sensing.	Stop at once	Manual

※ Please push PRG button in 2 successive time if you want to reset manually in terms of meeting reset condition. (It is also applicable to reset the power)

※ 1) Internal Control factor error

Occurrence : When internal important control variable has been changed due to external strong magnetic or noise.
Reset : Resetting variable value and reboot

※ 2) Discharge gas over temp.

It Occur that Discharge gas temp. is more {Alarm}Discharge gas high temp trip) set temp.

Reset : Discharge gas temp. is less than Discharge gas high trip - 10°C

e.g) Discharge gas high temp trip Set temp. = 110°C , If Discharge gas temp. is higher than 110°C, Discharge gas high temp trip Occur & After temp.is lower than 100°C, You can Reset

RUN INFO. MESSAGE

ITEM	DESCRIPTION	CODE	REMARK	A NOTE
1	Pump Down State	<i>Pdn</i>	Display at Pump down state (Shift Display with Pump down count time)	
2	Re-running Delay State	<i>rdy</i>	Display at Re-running delay state (Shift Display with Re-running delay count time)	Display at no use discharge gas sensor
3	Comp On State	<i>On</i>	Display at Comp. Start Operation	Display at no use discharge gas sensor
4	Comp Off State	<i>OFF</i>	Display at Comp. Stop Operation	Display at no use discharge gas sensor
5	Start State	<i>run</i>	Flickering for 2sec. When Change start running mode.	
6	Stop State	<i>StP</i>	Flickering for 2sec. When Change stop running mode.	

1.5 Time parameter setting

ITEM	DESCRIPTION	CODE	UNIT	STEP	MIN	MAX	DEFAULT
105	Start delay time	<i>Sdt</i>	Sec	1	0	600	5
106	SOL valve ON delay time	<i>SLt</i>	Sec	1	0	300	1
107	Comp. operation delay time	<i>Clt</i>	Sec	1	0	300	3
108	Comp. Re-running delay time	<i>rSt</i>	Sec	1	0	600	10
109	Pump. down delay time	<i>Pdt</i>	Sec	1	0	300	30
110	Injection valve operation temp.	<i>inv</i>	°C	1	60	150	95
111	Injection valve deviation	<i>ivf</i>	°C	1	-20	-1	-10

Start delay time(T_r) : Start operation delay time when meet the conditions
(While using many equipments, set up the successive start delay time.)

SOL valve ON delay time(T_s) : SOL valve ON delay time After start operation.

Comp. operation delay time(T_c) : Comp. Operation again delay time After SOL valve open.
(if Low Pressure Switch is ON)

Pump. down delay time(T_p) :

In case of LPS OFF, before Pump down time over then Comp OFF.
(If Pump down & LPS is return, Keep Comp OFF)
If Not LPS OFF, before Pump down time over, by Comp OFF forced time

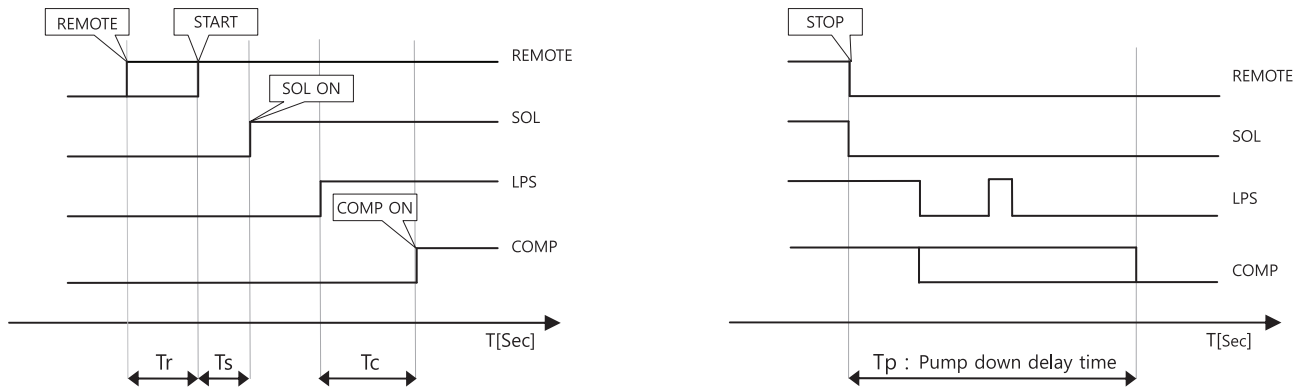

Re-running delay time(T_d) : After Comp OFF, Comp ON again delay time
(But, If LP Alarm sensitive is setting Comp OFF by LPS, Comp ON After Comp. Re-running delay time.)

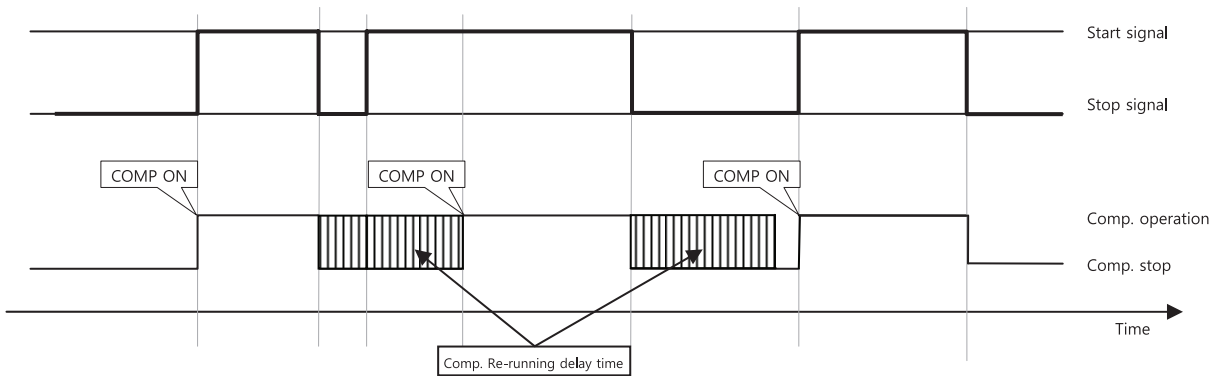

2. AL Alarm parameter setting

ITEM	DESCRIPTION	CODE	UNIT	STEP	MIN	MAX	DEFAULT
203	Discharge gas L temp. sensing delay time	<i>dtñ</i>	Sec	1	0	999	300
204	Discharge gas L temp. trip	<i>dtē</i>	°C	1	0	150	60
205	Discharge gas over temp. trip	<i>dct</i>	°C	1	0	150	110
206	LP alarm sensitivity setting(× 1)	<i>LPe</i>	a time	1	0	60	1
207	LP alarm sensitivity delay time(× 1)	<i>Ldt</i>	Sec	1	0	600	10
208	Interlock alarm sensing delay time(× 2)	<i>ilt</i>	Sec	1	0	300	0
209	Interlock alarm operation delay time(× 2)	<i>ilo</i>	Sec	1	0	300	0
210	High temp. alarm sensing sensitivity	<i>thi</i>	K	0.1	0	50.0	5.0
211	Low temp. alarm sensing sensitivity	<i>elo</i>	K	0.1	0	50.0	3.0
212	High temp. alarm sensing delay time	<i>thd</i>	Min	1	0	240	60
213	Low temp. alarm sensing delay time	<i>eld</i>	Min	1	0	240	0

* If Hig/Low temp. alarm sensing sensitivity is no, do not High & Low temp. alarm sensing.

(※ 1) Low Pressure alarm : according to LPS input state, You can use LPS various function

Low Pressure alarm mode	{Alarm} LP alarm sensing delay time) Set value	{Alarm} LP alarm sensitive) Set value	LOW PRESSURE ALARM OCCUR CONDITION
MODE 1	0 sec	0회	Not Occur Low Pressure alarm (But, Start/Stop, Pump down is operation by LPS)
MODE 2		1 ~ 60회	If LPS OFF, Occur Low Pressure alarm without condition
MODE 3	1 ~ 600 sec	0회	If LPS OFF After SOL valve open & Low Pressure alarm sensing delay time, Occur Low Pressure alarm
MODE 4		1 ~ 60회	If LPS OFF After SOL valve open & Low Pressure alarm sensing delay time, Occur Low Pressure alarm If LPS OFF more frequency than Low Pressure sensitive, After SOL valve open & Low Pressure alarm sensing delay time, Occur Low Pressure alarm

(※ 2) Interlock alarm : according to interlock signal input state, You can use interlock signal various function (Used flow alarm)

Interlock alarm mode	{Alarm} Interlock alarm sensing delay time) Set value	{Alarm} Interlock alarm sensitive) Set value	INTERLOCK ALARM OCCUR CONDITION
MODE 1	0 sec	1 ~ 60 sec	Always sensing have no Operation, If not Input Interlock signal for Interlock alarm start delay time, Occur Interlock alarm
MODE 2	1 ~ 300 sec		Start Sensing After start from Interlock alarm sensing delay time, If not Input Interlock signal for Interlock alarm start delay time, Occur Interlock alarm. (But, Start time is After that Remote operation input signal ON time)

3. In Digital Input parameter setting

ITEM	DESCRIPTION	CODE	CONTENTS	DEFAULT
300	Over current Input	OCr	<p>OFF (Unused) NO_P (Normal Open) NCL (Normal Close)</p> <p>if you unused digital input signal is setting OFF, you don't need to connection</p>	NCL
301	Comp. Over thermo Input	ICt		NCL
302	High Pressure Switch Input	HPS		NCL
303	Oil Pressure Switch Input (if Phase fail sensing input OFF)	OPS		NCL
304	Phase fail sensing Input (if Oil Pressure Switch input OFF)	Pr		OFF
305	Low Pressure Switch Input	LPS		NCL
306	Interlock alarm Input	ILC		NCL
307	Remote operation Input	ROt	OFF	

* If remote operation input is OFF, You can Start/Stop use of RUN / STOP button.

4. Out Digital Output parameter setting

ITEM	DESCRIPTION	CODE	CONTENTS	DEFAULT
405	SOL valve output	LSL	NO Unused	YES
406	Injection valve output	ISL	YES Use	YES

* If You Unused SOL valve output, Stop Pump down function & do not display that (time parameter|SOL valve ON delay time), (time parameter|Pump down delay time)

* If You Unused Injection valve output, Stop Injection valve & do not display that (time parameter|Injection valve operation temp), (time parameter|Injection valve deviation)

5. Set Extended parameter setting

ITEM	DESCRIPTION	CODE	UNIT	STEP	MIN	MAX	DEFAULT
500	Operation Mode	LYP	ON : Always Operation C : Cooling H : Heating				C
501	Temp. Display Mode	dIS	PB : assumed Ctrl. Temp. b1 : Outlet Temp. b2 : Inlet Temp. b3 : Discharge gas Temp.				PB
502	Outlet Temp. Sensor Used	b1E	no : Unuse, YES : Use				YES
503	Outlet Temp. Sensor Correction	b1F	K	0.1	-19.9	+19.9	0.0
504	Inlet Temp. Sensor Used	b2E	no : Unuse, YES : Use				no
505	Inlet Temp. Sensor Correction	b2F	K	0.1	-19.9	+19.9	0.0
506	Inlet Temp. Sensor Control Rate	brE	%	1	0	100	0
508	Discharge Temp Sensor Used	b3E	no : Unuse, YES : Use				YES
509	Discharge Temp Sensor Correction	b3F	K	1	-20	+20	0
511	Comm. ID Set	Id	-	1	1	128	1
512	Comm. Baudrate Set	bPS	-	48 : 4800, 96 : 9600, 192 : 19200, 384 : 38400 BPS			96 : 9600
513	Password Change	LoC	-	1	0	999	5 (no : lock is cancel)

* If You Unused Discharge gas temp sensor, do not display that(Injection valve operation temp., Injection valve deviation, Discharge gas high temp trip, Injection valve output, Discharge gas temp sensor correction)

* Inlet temp. sensor Control rate : PV is operation by Outlet & Inlet temp sensor rate.

e.g) In case of 0% , PV is peration by Outlet sensor is 100%, Inlet sensor is 0%. In case of 40%, PV is peration by Outlet sensor is 60%, Inlet sensor is 40%.

If You are operation by Inlet temp sensor only, you could Setting 100%.